



Electrical & Automation



EXORA HAI TOH SAFE HAI

Final Distribution Products - EXORA

EXORA

ABOUT US

Lauritz Knudsen Electrical & Automation, formerly known as L&T Switchgear, is a leading player in the electrical industry owing to its 70+ years of strong legacy and commitment to the nation's growth. The brand is dedicated to providing a wide range of electrical and automation products and solutions to vital sectors of the economy, including industries, utilities, infrastructure, buildings, and agriculture. Our extensive portfolio includes low-voltage and medium-voltage switchgear, automation solutions, tailored software, and services.

With manufacturing operations in Ahmednagar, Vadodara, and Coimbatore, we adhere to global standards of excellence. Our operations are supported by well-equipped, in-house design and development centers, as well as tooling facilities, ensuring precision in manufacturing.

We proudly operate six Switchgear Training Centers (STCs) across Pune, Lucknow, Coonoor, Vadodara, Delhi, and Kolkata. These centers offer tailor-made classroom courses and lab learning experiences for technicians, customers, engineers, professionals, and students.

With a deep national presence and one of the largest electrical distribution networks, comprising over 1500 partners across the country, we are committed to driving excellence and delivering superior products and solutions that power India's growth journey.

EXORA

Lauritz Knudsen- Electrical & Automation, offers this range of Modular Devices - EXORA - to ensure a safe environment around you. Protection and Control devices offered in this range provide safety at your home and at your workplace. Salient features of this range- Quick Break Mechanism, True Contact Position Indicator, Energy Limitation Class 3- enhance safety of human lives and precious belongings.

Further, Low Watt loss of these products reduces the amount of electricity consumed and results in low electricity expense. Features such as Biconnect and Two Position DIN Clip provide flexibility and ease of operation.



Modular Devices

MINIATURE CIRCUIT BREAKERS (MCBs)

1

RESIDUAL CURRENT CIRCUIT BREAKERS (RCCBs)

10

ISOLATORS

14

TECHNICAL INDEX

19



Miniature Circuit Breakers (10kA)



MCBs are vital protection devices. They are essential in every electrical installation to safeguard both your life and valuable property against short-circuit and overload faults.

Features and Benefits

- › Conforms to IS/IEC 60898-1, IEC 60947-2
- › Characteristic Tripping curves B, C & D
- › Energy limiting Class 3 allows low let-through energy in the system
- › Unique patented design gives both label holder and true contact indication facility for individual poles
- › Low watt loss- Almost 50% of the values prescribed by IEC 60898-1 saves energy
- › Trip free mechanism to ensure maximum safety
- › Design based on advanced current limiting hammer trip mechanism ensures quick breaking
- › No line load bias gives flexibility for incomer supply termination on either sides
- › Connection- Biconnect on both sides of MCB
- › Accessories- Wide range of accessories like aux contact, trip alarm contact and shunt release
- › DC MCB as per IEC 60947-2: Rated Voltage: 130/250 V DC (SP/DP), 250/500 V DC (SP/DP) , 1000V DC (DP)
- › CE conformity



Terminals suitable up to 35 sq mm cable



2- position Din Rail clip (Spring less)- Ease of Installation

Connection- Biconnect on both sides of MCB

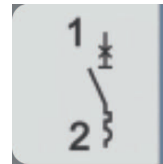

Suitable for isolation- Safe to do downstream maintenance



Lauritz Knudsen
C16
BB10160C 10000
240/415V~ 3
EN/IEC 60898-1

O-OFF



Label Holder



True Contact Indication- Enhanced safety



IP-20 Finger-proof terminals- Eliminate chances of accidental contact

Technical Specifications - MCBs

Specification	MCBs: IS / IEC 60898-1, IEC 60947-2	
	Current Rating	0.5 to 63A
Tripping Characteristic	B, C and D curve	
Breaking Capacity	IS/IEC 60898-1* : 10 kA	
	IEC 60947-2 (C Curve)	15kA (0.5A to 40A)- 10kA (50A & 63A)
Rated Voltage	240 / 415V AC	
Frequency	50 & 60 Hz	
Rated Impulse Voltage	4 kV	
Rated Insulation Voltage	500 V	
Minimum Operating Voltage	24 V AC / DC	
Degree of Protection	IP 20	
Applied Connection Torque	4 Nm	
Operating Temperature	- 25° C to + 70° C	
Calibration Temperature	30° C	
Termination Capacity	35 mm ² (Rigid) 25 mm ² (Flexible)	
Mechanical Life (operating cycles)	>100,000	
Electrical Life (operating cycles)	20,000 (cos Ø = 0.85 to 0.9) 6A to 32A 10,000 (cos Ø = 0.85 to 0.9) for 40A to 63A	
Mounting Position	Horizontal/Vertical/Flat	
Mounting	Snap fixing on standard profile 35 X 7.5mm DIN-Rail as per EN 50022	





* 50A & 63A D-Curve : IEC 60898-1

Dimension

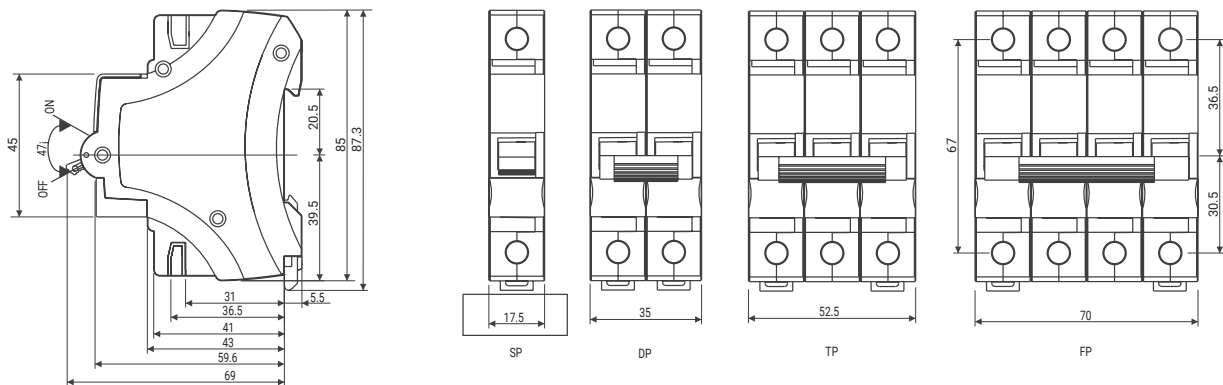
All dimensions are in mm



Single-Pole (SP)	Current Rating (In)	Modules 1 Mod= 17.5mm	B-Curve Cat. Nos.	C-Curve Cat. Nos.	D-Curve Cat. Nos.	DC MCBs Cat. Nos. (130 V)	DC MCBs Cat. Nos. (250 V)
	0.5A	1	-	BB10E50C	BB10E50D	BB10E5DC	BJ10E5DC
	1A	1	-	BB10010C	BB10010D	BB1001DC	BJ1001DC
	2A	1	-	BB10020C	BB10020D	BB1002DC	BJ1002DC
	3A	1	-	BB10030C	BB10030D	BB1003DC	BJ1003DC
	4A	1	-	BB10040C	BB10040D	BB1004DC	BJ1004DC
	6A	1	BB10060B	BB10060C	BB10060D	BB1006DC	BJ1006DC
	10A	1	BB10100B	BB10100C	BB10100D	BB1010DC	BJ1010DC
	16A	1	BB10160B	BB10160C	BB10160D	BB1016DC	BJ1016DC
	20A	1	BB10200B	BB10200C	BB10200D	BB1020DC	BJ1020DC
	25A	1	BB10250B	BB10250C	BB10250D	BB1025DC	BJ1025DC
	32A	1	BB10320B	BB10320C	BB10320D	BB1032DC	BJ1032DC
	40A	1	BB10400B	BB10400C	BB10400D	BB1040DC	BJ1040DC
	50A	1	BB10500B	BB10500C	BB10500D	BB1050DC	-
	63A	1	BB10630B	BB10630C	BB10630D	BB1063DC	-

Double-Pole (DP)	Current Rating (In)	Modules 1 Mod= 17.5mm	B-Curve Cat. Nos.	C-Curve Cat. Nos.	D-Curve Cat. Nos.	DC MCBs Cat. Nos. (250 V)	DC MCBs Cat. Nos. (500 V)
	0.5A	2	-	BB20E50C	BB20E50D	BB20E5DC	BJ20E5DC
	1A	2	-	BB20010C	BB20010D	BB2001DC	BJ2001DC
	2A	2	-	BB20020C	BB20020D	BB2002DC	BJ2002DC
	3A	2	-	BB20030C	BB20030D	BB2003DC	BJ2003DC
	4A	2	-	BB20040C	BB20040D	BB2004DC	BJ2004DC
	6A	2	BB20060B	BB20060C	BB20060D	BB2006DC	BJ2006DC
	10A	2	BB20100B	BB20100C	BB20100D	BB2010DC	BJ2010DC
	16A	2	BB20160B	BB20160C	BB20160D	BB2016DC	BJ2016DC
	20A	2	BB20200B	BB20200C	BB20200D	BB2020DC	BJ2020DC
	25A	2	BB20250B	BB20250C	BB20250D	BB2025DC	BJ2025DC
	32A	2	BB20320B	BB20320C	BB20320D	BB2032DC	BJ2032DC
	40A	2	BB20400B	BB20400C	BB20400D	BB2040DC	BJ2040DC
	50A	2	BB20500B	BB20500C	BB20500D	BB2050DC	-
	63A	2	BB20630B	BB20630C	BB20630D	BB2063DC	-

Three-Pole (TP)	Current Rating (In)	Modules 1 Mod= 17.5mm	B-Curve Cat. Nos.	C-Curve Cat. Nos.	D-Curve Cat. Nos.
	0.5A	3	-	BB30E50C	BB30E50D
	1A	3	-	BB30010C	BB30010D
	2A	3	-	BB30020C	BB30020D
	3A	3	-	BB30030C	BB30030D
	4A	3	-	BB30040C	BB30040D
	6A	3	BB30060B	BB30060C	BB30060D
	10A	3	BB30100B	BB30100C	BB30100D
	16A	3	BB30160B	BB30160C	BB30160D
	20A	3	BB30200B	BB30200C	BB30200D
	25A	3	BB30250B	BB30250C	BB30250D
	32A	3	BB30320B	BB30320C	BB30320D
	40A	3	BB30400B	BB30400C	BB30400D
	50A	3	BB30500B	BB30500C	BB30500D
	63A	3	BB30630B	BB30630C	BB30630D

Four-Pole (FP)	Current Rating (In)	Modules 1 Mod= 17.5mm	B-Curve Cat. Nos.	C-Curve Cat. Nos.	D-Curve Cat. Nos.
	0.5A	4	-	BB40E50C	BB40E50D
	1A	4	-	BB40010C	BB40010D
	2A	4	-	BB40020C	BB40020D
	3A	4	-	BB40030C	BB40030D
	4A	4	-	BB40040C	BB40040D
	6A	4	BB40060B	BB40060C	BB40060D
	10A	4	BB40100B	BB40100C	BB40100D
	16A	4	BB40160B	BB40160C	BB40160D
	20A	4	BB40200B	BB40200C	BB40200D
	25A	4	BB40250B	BB40250C	BB40250D
	32A	4	BB40320B	BB40320C	BB40320D
	40A	4	BB40400B	BB40400C	BB40400D
	50A	4	BB40500B	BB40500C	BB40500D
	63A	4	BB40630B	BB40630C	BB40630D

Technical Specifications - DC MCBs

Specification	DC MCBs - IEC 60947-2	
	Current Rating	0.5 to 63A
Tripping Characteristic	C curve	C curve
Breaking Capacity	6kA	10kA
Rated Voltage	130V DC - Single Pole 250V DC - Double Pole 1000V DC - Double Pole	250V DC - Single Pole 500V DC - Double Pole
Supply	Polarity independent (130V DC & 250V DC) Polarity dependent (1000V DC)	Polarity dependent*
Rated Impulse Voltage	4 kV [#]	
Rated Insulation Voltage	500 V	
Minimum Operating Voltage	24 V DC	
Degree of Protection	IP 20	
Applied Connection Torque	4 Nm	
Operating Temperature	- 25° C to + 70° C	
Calibration Temperature	30° C	
Termination Capacity	35 mm ² (Rigid) 25 mm ² (Flexible)	
Mechanical Life (operating cycles)	>100,000	
Electrical Life (operating cycles)	3000 (L/R=2mS)	
Mounting Position	Horizontal/ Vertical/ Flat	
Mounting	Snap fixing on standard profile 35 X 7.5mm DIN-Rail as per EN 50022	



*Refer connection diagram below for connection
[#]6 kV for 1000V DC MCBs

Dimension

Connection diagram for 250/ 500 V DC MCBs

All dimensions are in mm

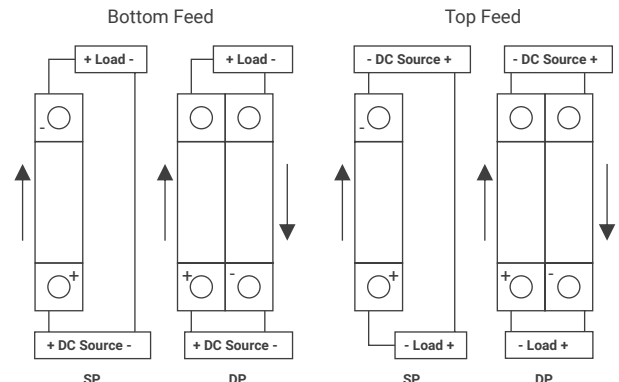
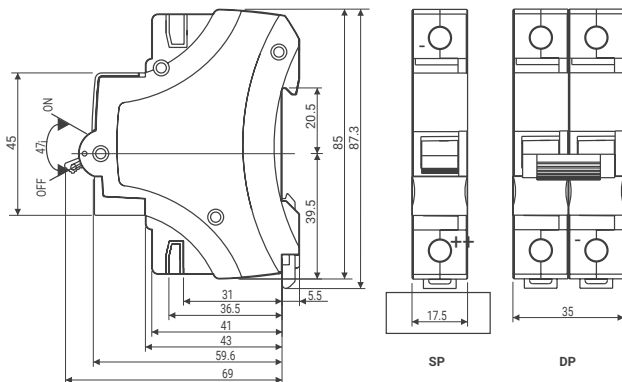

Solar Combo MCBs

Complete Protection for Solar Rooftop Installations

Combo Pack

Tested for Reliable
Performance



DC MCB

AC MCB

- [1 DP DC (500V) MCB] + [1 DP AC MCB] in a combo pack
- Provides complete protection for DC and AC sides of solar rooftop installations
- DC MCB : 10kA as per IEC 60947-2
- AC MCB : 10kA as per IS/IEC 60898-1



Customer Interaction Center (CIC)

Phone no: 022 6932 7800

Web: www.LK-EA.com | e-mail: CIC@LK-EA.com

Miniature Circuit Breaker (MCBs) [8536]

DC MCBs as per IEC 60947-2 [8536]

Rated Voltage: Breaking capacity of 6 kA - BB Series DC MCBs
130V DC SP MCB

Rating	Modules 1 Mod = 17.5mm	Cat. No.
0.5A	1	BB10E5DC
1A	1	BB1001DC
2A	1	BB1002DC
3A	1	BB1003DC
4A	1	BB1004DC
6A	1	BB1006DC
10A	1	BB1010DC
16A	1	BB1016DC
20A	1	BB1020DC
25A	1	BB1025DC
32A	1	BB1032DC
40A	1	BB1040DC
50A	1	BB1050DC
63A	1	BB1063DC

Rated Voltage: Breaking capacity of 10 kA - BJ Series DC MCBs
250V DC SP MCB

Rating	Modules 1 Mod = 17.5mm	Cat. No.
0.5A	1	BJ10E5DC
1A	1	BJ1001DC
2A	1	BJ1002DC
3A	1	BJ1003DC
4A	1	BJ1004DC
6A	1	BJ1006DC
10A	1	BJ1010DC
16A	1	BJ1016DC
20A	1	BJ1020DC
25A	1	BJ1025DC
32A	1	BJ1032DC
40A	1	BJ1040DC
50A	1	BJ1050DC
63A	1	BJ1063DC

250V DC DP MCB

0.5A	2	BB20E5DC
1A	2	BB2001DC
2A	2	BB2002DC
3A	2	BB2003DC
4A	2	BB2004DC
6A	2	BB2006DC
10A	2	BB2010DC
16A	2	BB2016DC
20A	2	BB2020DC
25A	2	BB2025DC
32A	2	BB2032DC
40A	2	BB2040DC
50A	2	BB2050DC
63A	2	BB2063DC

500V DC DP MCB

0.5A	2	BJ20E5DC
1A	2	BJ2001DC
2A	2	BJ2002DC
3A	2	BJ2003DC
4A	2	BJ2004DC
6A	2	BJ2006DC
10A	2	BJ2010DC
16A	2	BJ2016DC
20A	2	BJ2020DC
25A	2	BJ2025DC
32A	2	BJ2032DC
40A	2	BJ2040DC
50A	2	BJ2050DC
63A	2	BJ2063DC

Note: Standard Pack Quantity for MCB : SP - 12 Nos., DP - 6 Nos.

1000V DC MCBs [8536]

Rated Voltage: 1000V DC with breaking capacity of 6 kA - BK Series DC MCBs

Description	Modules 1 Mod = 17.5mm	Cat. No.
DP 6A 1000V DC 6kA MCB	4	BK2006DC
DP 10A 1000V DC 6kA MCB	4	BK2010DC
DP 16A 1000V DC 6kA MCB	4	BK2016DC
DP 20A 1000V DC 6kA MCB	4	BK2020DC
DP 25A 1000V DC 6kA MCB	4	BK2025DC
DP 32A 1000V DC 6kA MCB	4	BK2032DC
DP 40A 1000V DC 6kA MCB	4	BK2040DC
DP 50A 1000V DC 6kA MCB	4	BK2050DC
DP 63A 1000V DC 6kA MCB	4	BK2063DC

Solar Combo MCBs [8536]

(AC MCB + DC MCB)

Description	Modules 1 Mod = 17.5mm	Cat. No.
1 AC 16A DP MCB* + 1 DC 16A DP 500V MCB	2+2	SC221616
1 AC 25A DP MCB* + 1 DC 16A DP 500V MCB	2+2	SC222516
1 AC 32A DP MCB* + 1 DC 16A DP 500V MCB	2+2	SC223216
1 AC 32A DP MCB* + 1 DC 32A DP 500V MCB	2+2	SC223232

*AC MCB with C-Curve

Auxiliaries and Accessories

10 kA MCBs

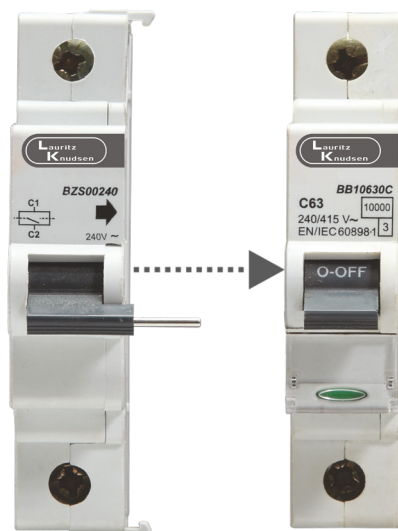

Lauritz Knudsen- Electrical & Automation MCBs can be fitted with a wide range of accessories like Auxiliary Contact, Shunt Release and Trip Alarm Contact.

Auxiliary & Accessories for 10kA MCBs

Description	Modules 1 Mod = 17.5mm	Cat. Nos.
Auxiliary Contact - 240V AC, 6A (1NO+1NC)	0.5	BZA11006
Shunt Release - 240V AC	1	BZS00240
Trip Alarm Contact - 240V AC, 6A (1NO + 1NC)	0.5	BZT11006

Residual Current Circuit Breakers (RCCBs)



Residual Current Circuit Breakers provide protection against earth leakage fault. They ensure safety of human life in case of earth leakage fault and protection against electric shock.

Features and Benefits

- › Conforms to IS 12640-(Part 1), IEC 61008-1
- › Rated conditional short-circuit current 10 kA
- › E&A RCCBs are available in DP and FP versions from 25A to 100A ratings with 30mA, 100mA and 300mA sensitivity
- › Truly current operated – operation even at low voltage
- › Operates on Core Balance Current Transformer (CBCT) principle
- › Neutral advance mechanism ensures complete protection
- › Finger-proof terminal (IP 20)
- › Connection - Biconnect on both sides of RCCB



Finger- Proof terminal- IP 20



Connection- Biconnect suitable for Busbar and/ or wire up to 50 sq mm



Test button- Facilitates to check healthiness of device by creating an artificial electrical fault



Combi- Head screws- Allows use of standard as well as Philips head screwdriver

Technical Specifications - RCCBs

Specification	RCCBs: IS 12640 – Part 1/ IEC 61008-1
RCCB Type AC RCCB Type	AC
Rated Current (In)- A	25, 40, 63, 100
Operating Sensitivity – mA	30, 100, 300
No. of Poles	2 Pole & 4 Pole
Rated Voltage	240/415 V AC
Rated Frequency	50Hz & 60Hz*
Rated Insulation Voltage	500 V
Rated Impulse Withstand Voltage	4 kV
Rated Conditional Short-Circuit Current	10 kA
Rated Residual Making and Breaking Capacity	1 kA
Degree of Protection	IP 20
Termination Capacity	50 mm ² (Rigid) 35 mm ² (Flexible)
Operating Temperature	-5°C to + 55°C
Mechanical Life (Operating cycles)	20,000
Electrical Life (up to 63A) (Operating cycles)	10,000
Mounting Arrangement	Snap- fit on 35 mm DIN-Rail

*For 60Hz requirement, Please contact nearest sales branch

Note : For back-up short circuit protection device, please refer to page no. 30

Dimension

All dimensions are in mm

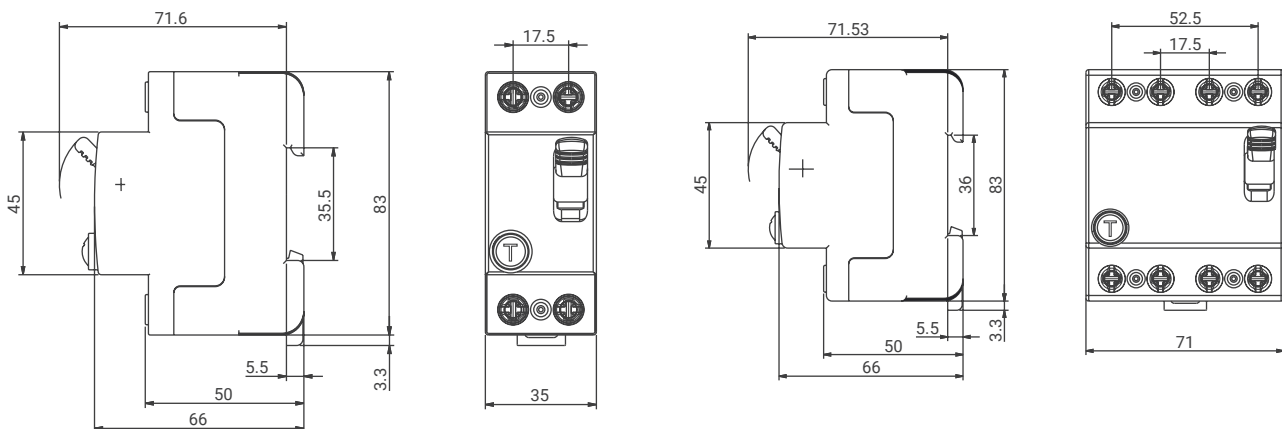

Double-Pole (DP)	Current Rating (In)	Sensitivity	Modules 1 Mod= 17.5mm	Cat Nos.
	25A	30mA	2	BG202503
		100mA	2	BG202510
		300mA	2	BG202530
	40A	30mA	2	BG204003
		100mA	2	BG204010
		300mA	2	BG204030
	63A	30mA	2	BG206303
		100mA	2	BG206310
		300mA	2	BG206330
	100A	30mA	2	BG210003
		100mA	2	BG210010
		300mA	2	BG210030

Four-Pole (FP)	Current Rating (In)	Sensitivity	Modules 1 Mod= 17.5mm	Cat Nos.
	25A	30mA	4	BG402503
		100mA	4	BG402510
		300mA	4	BG402530
	40A	30mA	4	BG404003
		100mA	4	BG404010
		300mA	4	BG404030
	63A	30mA	4	BG406303
		100mA	4	BG406310
		300mA	4	BG406330
	100A	30mA	4	BG410003
		100mA	4	BG410010
		300mA	4	BG410030

Isolators



Isolators are used in electrical installations to make, carry and break circuit current. The Isolator ensures that the circuit remains completely isolated i.e. there will be no current at the load side even if the impulse voltage appears when the isolator is OFF.

Features and Benefits

- › Conforms to EN/IEC 60947-3
- › Suitable for AC22-A Utilization Category
- › Available in DP, TP and FP versions in 40A, 63A, 80A and 100A ratings
- › Easy mounting due to 'Two-position DIN-Rail clip'
- › Combi-head screws- Allows use of multiple screwdrivers
- › True contact indication- Enhances Safety
- › CE and KEMA certified



Connection - Biconnect
Terminals suitable up to
35 sq mm cable



2- position Din Rail clip
(Spring less)- Ease of Installation



True Contact
Indication –
enhanced safety



IP-20 Finger-proof terminals – eliminate
chances of accidental contact

Technical Specifications - Isolators

Specification	Isolators: EN / IEC 60947 – 3
Rated Current (In)	40A, 63A, 80A, 100A
No. of Poles	2, 3 and 4 Pole
Rated Operational Voltage (AC)	240/415 V
Rated Frequency	50 Hz
Rated Insulation Voltage	500 V
Rated Impulse Voltage	4 kV
Utilization Category	AC 22A
Degree of Protection	IP 20
Termination Capacity	35 mm ² (Rigid) 25 mm ² (Flexible)
Operating Temperature	-5°C to + 50°C
Mounting Arrangement	Snap-fit on 35 mm DIN rail
Rated Short Time Withstand Current, Icw	12 In , 1 sec

Dimension

All dimensions are in mm

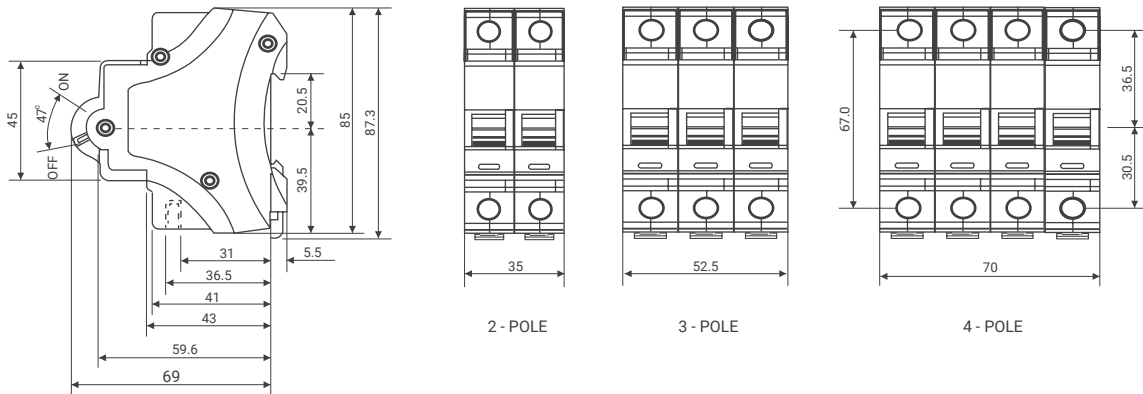

Double Pole (DP)	Current Rating (In)	Modules 1Mod = 17.5mm	Cat. Nos
	40	2	BF204000
	63	2	BF206300
	80	2	BF208000
	100	2	BF210000

Three Pole (TP)	Current Rating (In)	Modules 1Mod = 17.5mm	Cat. Nos
	40	3	BF304000
	63	3	BF306300
	80	3	BF308000
	100	3	BF310000

Four Pole (FP)	Current Rating (In)	Modules 1Mod = 17.5mm	Cat. Nos
	40	4	BF404000
	63	4	BF406300
	80	4	BF408000
	100	4	BF410000

Ingress Protection (IP)

The protection of enclosures against ingress of dirt or against the ingress of water is defined in IEC529 (BSEN60529:1991). Conversely, an enclosure which protects equipment against ingress of particles will also protect a person from potential hazards within that enclosure, and this degree of protection is also defined as a standard.

The degrees of protection are most commonly expressed as 'IP' followed by two numbers, e.g. IP65, where the numbers define the degree of protection.









1st Digit

Protection against Human Contact/
Protection against Foreign Bodies

No special protection	0	
With back of hand/ large foreign bodies, diam. >50mm	1	
With a finger/ medium-sized foreign bodies, diam. >12.5mm	2	
With tools and wires etc. with a thickness >2.5mm/ small foreign bodies, diam. >2.5mm	3	
With tools and wires etc. with a thickness >1mm/ granular foreign bodies, diam. >1mm	4	
Complete protection/ dust protected	5	
Complete protection/ dust-proof	6	

2nd Digit

Protection against Water Ingress

No special protection	0	
Water dripping vertically	1	
Water dripping at an angle (up to 15 degrees from the vertical)	2	
Spray water (any direction up to 60 degrees from the vertical)	3	
Spray water from all directions	4	
Water jets from a nozzle in all directions	5	
High pressure jets	6	
Temporary immersion	7	
Permanent immersion	8	

Technical Index

1. Basics of Electrical System and General Electrical Practices

- 1.1 Types of Faults
- 1.2 Safety Requirements

2. Earthing Systems

- 2.1 Types of Earthing systems
- 2.2 Comparison of Earthing systems
- 2.3 Choice of Earthing

3. Miniature Circuit Breakers (MCBs)

- 3.1 Selection of MCBs
- 3.2 Application of different curves
- 3.3 Temperature de-rating chart
- 3.4 Current-limiting and Energy-limiting class
- 3.5 Important Definitions and Symbols of MCBs
- 3.6 Conditions for suitability for isolation as per IEC 60947-2
- 3.7 MCBs Characteristic Curves
- 3.8 Watt loss table

4. Residual Current Devices (RCDs)

- 4.1 Danger of Human – Electrocutation
- 4.2 Working of Residual Current Devices
- 4.3 Precautions for installation
- 4.4 Fault finding when RCCBs trips
- 4.5 RCCBs: Domestic Installation

1. Basics of Electrical System and General Electrical Practices

1.1 Types of Faults

A fault can be defined as any abnormal flow of electric current, in an electric power system.

Types of faults

Faults can be broadly classified into two main areas.

- › **Active Fault**
- › **Passive Fault**

› **Active Fault**

An 'Active' fault occurs when actual current flows from one phase conductor to another (phase-to-phase) or alternatively from one phase conductor to earth (phase-to-earth). This type of fault can also be further classified into two areas, namely the 'solid' fault and the 'incipient' fault.

› **Solid fault**

The solid fault occurs as a result of an immediate complete breakdown of insulation. For example a pick struck an underground cable, bridging conductors etc.

› **Incipient fault**

An incipient fault is a fault that starts from very small beginnings, saysome partial discharge (excessive electronic activity often referred to as corona) in a void in the insulation, increasing and developing over an extended period, until such time as it burns away adjacent insulation, eventually running away and developing into a "solid" fault.

› **Passive Fault**

Passive faults are not real faults in the true sense of the word, but are conditions that stress the system beyond its design capacity, so that ultimately active faults will occur. Examples of passive faults Overloading leading to overheating of insulation (deteriorating quality, reduced life and ultimate failure).

Overvoltage- stressing the insulation beyond its limits.

Under frequency- causing plant to behave incorrectly.

Power swings- generators going out-of-step or synchronism with each other.

1.2 Safety Requirements

Some of the important safety requirements in electrical installations in domestic dwellings are summarized below:

- › All outlets for domestic electrical appliances shall be of three-pin socket type, the third socket being connected to the earth.
- › All the single-pole switches shall be on phase or live conductor only.
- › The electrical outlets for appliances in the bathrooms shall be away from the shower or sink.
- › Wiring for power outlets in the kitchen shall be preferably done in metallic conduit wiring.
- › The electrical outlets shall not be located above the gas stove.
- › The clearance between the bottom-most point of the ceiling fan and the floor shall be not less than 2.4 m.
- › The metallic body of the fan regulator if any, shall be earthed effectively.
- › Earth leakage circuit-breaker at the intake of power supply at the consumer's premises shall be provided.

2. Earthing Systems

2.1 Types of Earthing systems

According to BS 7671 five types of earthing are specified. ults can be broadly classified into two main areas.

- › **TT- Earthing system**
- › **TN-SEarthing system**
- › **TN-C system**
- › **TN-C-S system**
- › **IT-system**

In the above systems,

T = Earth (from the French word Terre)

N = Neutral

S = Separate

C = Combined

I = Isolated

When designing an electrical installation, one of the first things to determine is the type of earthing system. The system will either be

TN-S, TN-C-S Protective Multiple Earthing (PME) or TT for a low voltage supply given in accordance with the Electricity Safety, Quality and Continuity Regulations 2002.

› **TT system -**

If the neutral of the source & protective earth (PE) conductor at the consumer end are earthed separately, the system is called TT system. The system is as shown in the figure. With TT, the consumer must provide their own connection to earth, i.e. by installing a suitable earth electrode local to the installation. The circumstances in which a distributor may not provide a means of earthing for the consumer where the distributor cannot guarantee the earth connection back to the source, e.g. a low voltage overhead supply or where there is the likelihood of the earth wire either becoming somehow disconnected or even stolen.

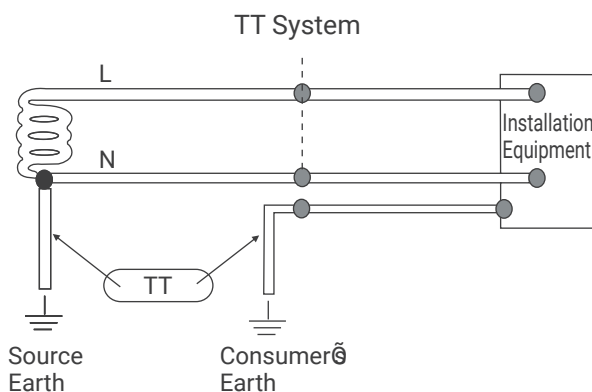

› **TN- S system-**

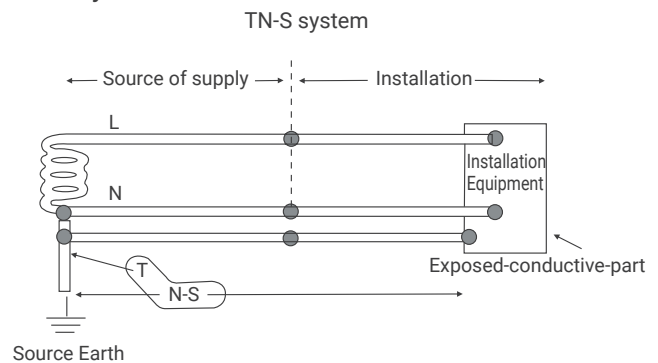

In this system, the N and PE neutral conductors are separate. PE and N conductors are mandatory for the circuits of cross-section less than 10 sq.mm.

A TN-S system has the neutral of the source of energy connected with earth at one point only, at or as near as is reasonably practicable to the source. The consumer's earthing terminal is typically connected to the metallic sheath or armour of the distributor's service cable into the premises or to a separate protective conductor of, for instance, an overhead supply. Large consumers may have one or more HV/LV transformers dedicated to their installation and installed adjacent to or within their premises. In such situations, the usual form of system earthing is TN-S.

› **TN-C system**

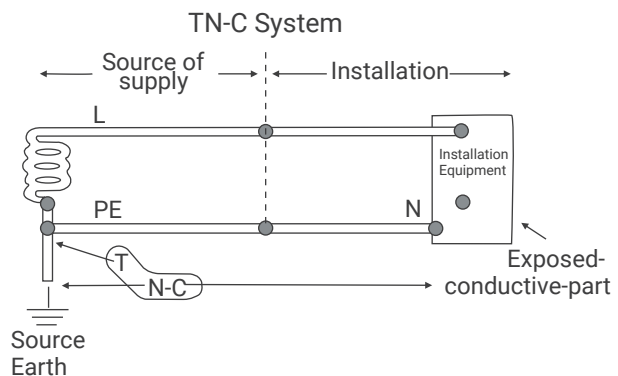

If the N and PE neutral conductors are one and the same (PEN) in the system than such a system is called a TN-C system. In this system RCD will trip in case of leakage only through human body. So this system is most the dangerous from the safety point of view.

› IT system

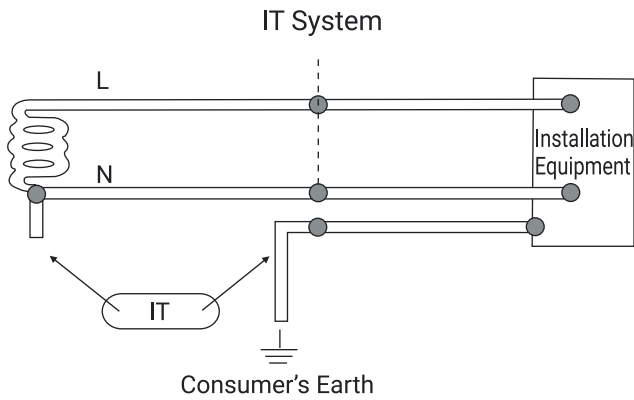

In an IT network, the distribution system has no connection to the earth at all, or it has only a high impedance connection. In such systems, an insulation monitoring device is used to monitor the impedance. Only the IT system guarantees risk-free continuity of supply in the presence of an insulation fault.

› TN- C- S system-

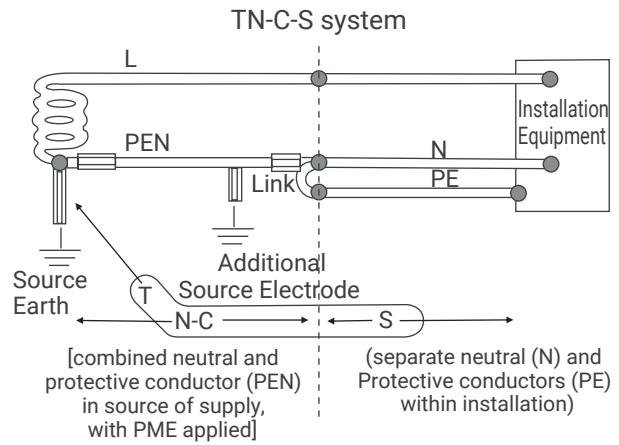

A TN-C-S system has the supply neutral conductor of a distribution main connected with earth at source and at intervals along its run. This is usually referred to as Protective Multiple Earthing (PME). With this arrangement the distributor's neutral conductor is also used to return earth fault currents arising in the consumer's installation safely to the source. To achieve this, the distributor will provide a consumer's earthing terminal which is linked to the incoming neutral conductor.

2.2 Comparison of Earthing systems

	TT	IT	TNS	TNC	TNC-S
Earth fault loop impedance	High	Highest	Low	Low	Low
RCD preferred?	Yes	No	Yes	No	After N and PE separate
Need earth electrode at site ?	Yes	Yes	Broken PE	No	No
PE conductor cost	Low	Low	No	Least	High
Risk of broken neutral	No	No	Highest	Highest	High
Safety	Safe	Less Safe	No	Less Safe	Safe
Electromagnetic interference	Least	Least	Safest	High	Low
Safety risks	High loop impedance	Double fault, Over-voltage	Low	Broken neutral	Broken neutral
Advantages	Safe and reliable	Continuity of operation, cost	Safest	Cost	Safety and cost

2.3 Choice of Earthing

Choice of earthing system for an installation depends on parameters:

- › Safety of person
- › Continuity of supply
- › Sensitivity of the equipment to the presence of harmonics in the system
- › Environment (risk of lightning strike)
- › Quality, maintenance and cost
- › Network size
- › Requirement of skilled operator and designer

3. Miniature Circuit Breaker (MCBs)

An MCB is an automatically operated electrical switch designed to protect an electrical circuit from damage caused by overload and short circuit. Its basic function is to detect a fault condition and, by interrupting continuity, to immediately discontinue electrical flow. Unlike a fuse, which operates once and then has to be replaced, a circuit breaker can be reset (manually) to resume normal operation.

3.1 Selecting an MCBs

In order to achieve perfect overload protection, the normal current of the MCB (I_m) should not be less than the design current of the circuit (I_c) and that (I_m) should not exceed the current-carrying capacity of the conductors (I_w), and that the current causing effective operation of the protective device I_m does not exceed 1.45 times the current-carrying capacity of the conductor I_c , expressed as; $I_c < I_m < I_w$ e.g. If for a load of 800w, 220V; load current is 4A then wire capacity should be minimum 11A (i.e. 1 sq mm) and MCB rating should be 6A.

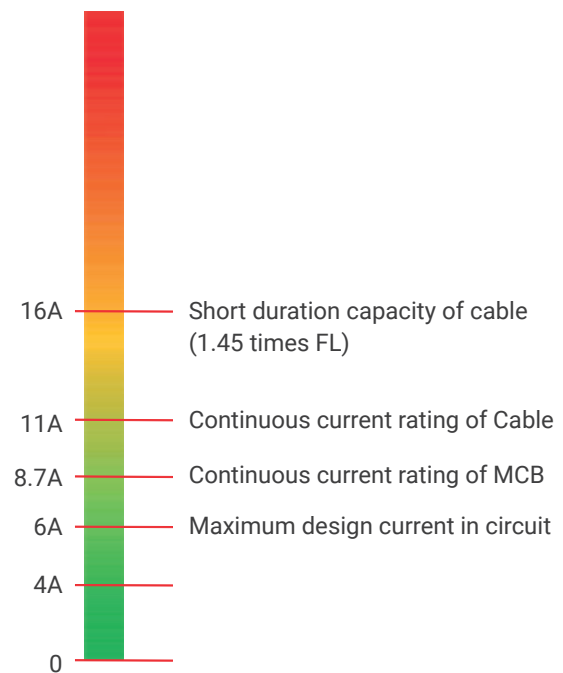

3.2 Application of Curves

Type	Setting	Application
B	3-5 I_n	Generator-sensitive loads very long circuit runs Example: Incandescent lights, Heater , Geyser
C	5-10 I_n	General, light and power Example: Flourescent lights, Small motors, Fans, Refrigerators Window / Split Acs
D	10-20 I_n	Motors & transformers sodium lighting highly inductive loads Example: Water lifting pumps, UPS, Medium size motors

3.3 Temperature de-rating chart

As per IS/IEC 60898, thermal calibration of an MCB is to be done at 30°C and if the manufacturer decides to do it at any other temperatures, the data has to be furnished on the breaker. When used at ambient temperatures exceeding the calibrated temperatures, MCBs tend to trip faster while carrying the

rated current. This calls for de-rating the MCBs when used in ambiances, with temperatures higher than the design ambient temperature. At temperature higher than 30°C, the MCB require progressively less time to trip on the same level of overload.

Temperature Derating chart as per IEC 60898-1 (Calibration temperature: 30°C):

Rating (A)	30° C	35° C	40° C	45° C	50° C	55° C	60° C	65° C	70° C
6	6.0	5.7	5.4	5.1	4.8	4.5	4.2	4.3	4.0
10	10.0	9.5	9.0	8.5	8.0	7.5	7.0	7.2	6.6
16	16.0	15.2	14.4	13.6	12.8	12.0	11.2	11.4	10.6
20	20.0	20.0	18.0	17.0	16.0	15.0	14.0	14.3	13.2
25	25.0	23.8	22.5	21.3	20.0	18.8	17.5	17.9	16.5
32	32.0	30.4	28.8	27.2	25.6	24.0	22.4	22.9	21.1
40	40.0	38.0	36.0	34.0	32.0	30.0	28.0	28.6	26.4
50	50.0	47.5	45.0	42.5	40.0	37.5	35.0	35.8	33.0
63	63.0	59.9	56.7	53.6	50.4	47.5	44.1	45.0	41.6

Temperature De-rating Chart as per IEC 60947-2 (Calibration Temperature: 50°C):

In(A)	30° C	35° C	40° C	45° C	50° C	55° C	60° C	65° C	70° C
6	6.6	6.5	6.3	6.2	6	5.7	5.4	5.1	4.8
10	11	10.8	10.5	10.3	10	9.5	9	8.5	8
16	17.6	17.2	16.8	16.4	16	15.2	14.4	13.6	12.8
20	22	22	21	20.5	20	19	18	17	16
25	27.5	26.9	26.3	25.6	25	23.8	22.5	21.25	20
32	35.2	34.4	33.6	32.8	32	30.4	28.8	27.2	25.6
40	44	43	42	41	40	38	36	34	32
50	55	53.8	52.5	51.3	50	47.5	45	42.5	40
63	69.3	67.7	66.2	64.6	63	59.9	56.7	53.55	50.4

3.4 De-rating chart for Miniature circuit breakers

Usage of MCBs at higher altitudes

De-rating at different altitudes (Voltage : 1% per 100 m; Current : 2% per 1000 m)							
Altitude	High	(m)	at 2000	2500	3001 to 4000	4001 to 5000	5001 to 6000
Rated operational voltage	Ue	(V)	415	394	332	290.5	249
Rated operational voltage	Ue	(V)	240	228	192	168	144
Rated current	Ie	(A)	Ie	0.98 Ie	0.96 Ie	0.93 Ie	0.92 Ie
Let through energy 2	Refer Below Note*						
Impulse withstand voltage 3	Uimp	(kV)	5.7	6	4.8	4.2	3.6
Rated insulation voltage 3	Ui	(V)	500	475	400	350	300

Notes:

- 1 Due to poor heat-dissipation, thermal current is greatly affected.
- 2 Increase in let-through energy of approx. 5% is expected which may be ignored owing to derating in voltage and current.
- 3 Dielectric properties practically remain un-affected at higher altitudes. However, de-rating is applied to maintain safety margin.

3.5 Current-limiting and Energy-limiting class

Current limitation is the technique used in circuit breakers to limit the short circuit current to reach its prospective value.

Current limitation can be achieved by following methods:

› By Limiting the Fault

- › CBy series resistors: using a series resistor to limit current on short circuit, but this wastes a lot of energy in limiting resistors.
- › By series inductors coil – lot of heat loss combined with bulky size of inductor coils.

› By Current Limiting Technology

- › A current limiting circuit breaker cuts off the fault current much before it attains its peak value and hence greatly reduces the thermodynamic stresses on an electrical network.
- › On a 50 Hz electrical network, fault current takes 5 msec to reach its prospective peak value.

A current limiting circuit breaker interrupts the fault current within 5 msec and clears the fault within 10 msec to limit the fault current and minimize let thru energy for maximum protection of electrical network.

Let thru energy is the amount of fault energy which passes through a circuit breaker to downstream network measured from the instant fault occurs in a system to the instant the circuit breaker clears the fault.

IEC classify MCBs into three classes depending upon their "Quality of current limiting" and let thru energy of a circuit breaker on short circuit class.

Class	Let thru energy
Class 1	No Limitation
Class 2	370 kA ² S
Class 3	110 kA ² S

As per EN-60898-1 -2003, for 10kA C-curve MCB (Greater than 16A up to and including 32A)

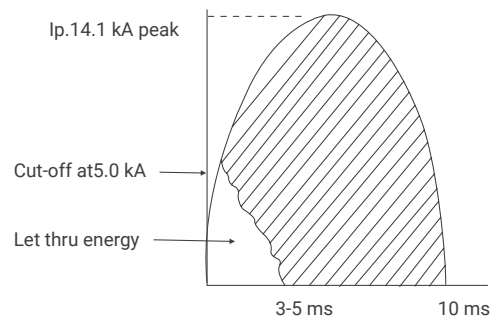

3.5 Some Important Definitions and Symbols

(National and International Standards)

- Ue = rated service voltage
- Ui = rated insulation voltage (>Uemax)
- Uimp = rated impulse withstand
- Icm = rated short circuit making capacity
- Icn = rated short circuit capacity
- Ics = rated service short circuit breaking capacity
- IΔn = rated residual operating current (often called residual sensitivity)

- In = rated current = maximum value of current used for the temperature rise test
- Δt = trip delay of residual current devices

Fault Current	Trip time
1.13 In	Greater than 1 hour
1.45 In	Less than 1 hour
2.55 In	1 to 120 seconds

The inverse time delay characteristics of all MCBs complying with IEC 60898 must operate within these limits.

The difference between three types of characteristic curve B, C and D concerns only the magnetic instantaneous trip which provides short circuit protection.

Curve type	Breaker trip limits
Type B	3 to 5 times In
Type C	5 to 10 times In
Type D	10 to 20 times In

3.6 Suitability for Isolation as per IEC 60947-2

As per IEC 60947-2, certain conditions, as mentioned below, needs to be satisfied by the product so that manufacturer can claim it to be suitable for isolation.

- › An isolation distance to be maintained in open position such that it satisfy the impulse withstand voltage and leakage current tests as per the standard.

- › Indication of the position of the main contacts shall be provided by one or more of the following means:
 - › the position of the actuator;
 - › a separate mechanical indicator;
 - › visibility of all the moving main contacts

Products which complies above condition can be marked as suitable for isolation symbol on the product: 

3.7 MCBs Characteristic Curves

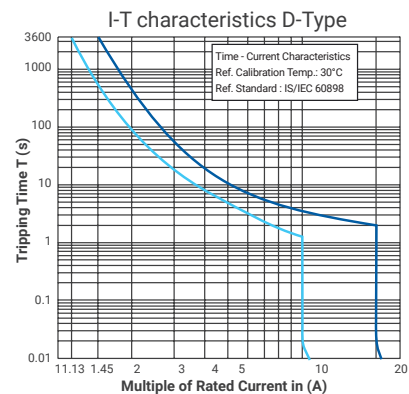
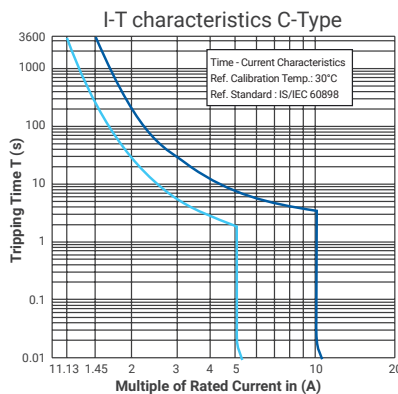
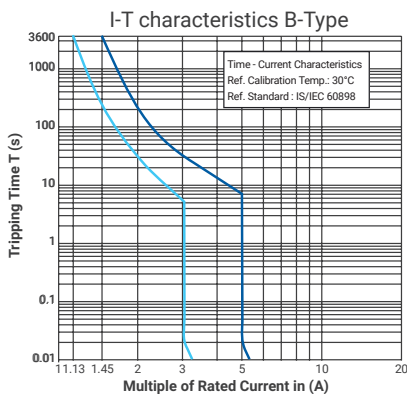

3.8 Watt loss table

Current (A) In	6	10	16	20	25	32	40	50	63
Loss (Watt)	1.36	1.8	1.8	2.49	3.52	3.4	3.75	5.17	5.93

4. Residual Current Circuit Breakers (RCCBs)

4.1 Danger of Human Safety - Electrocutation

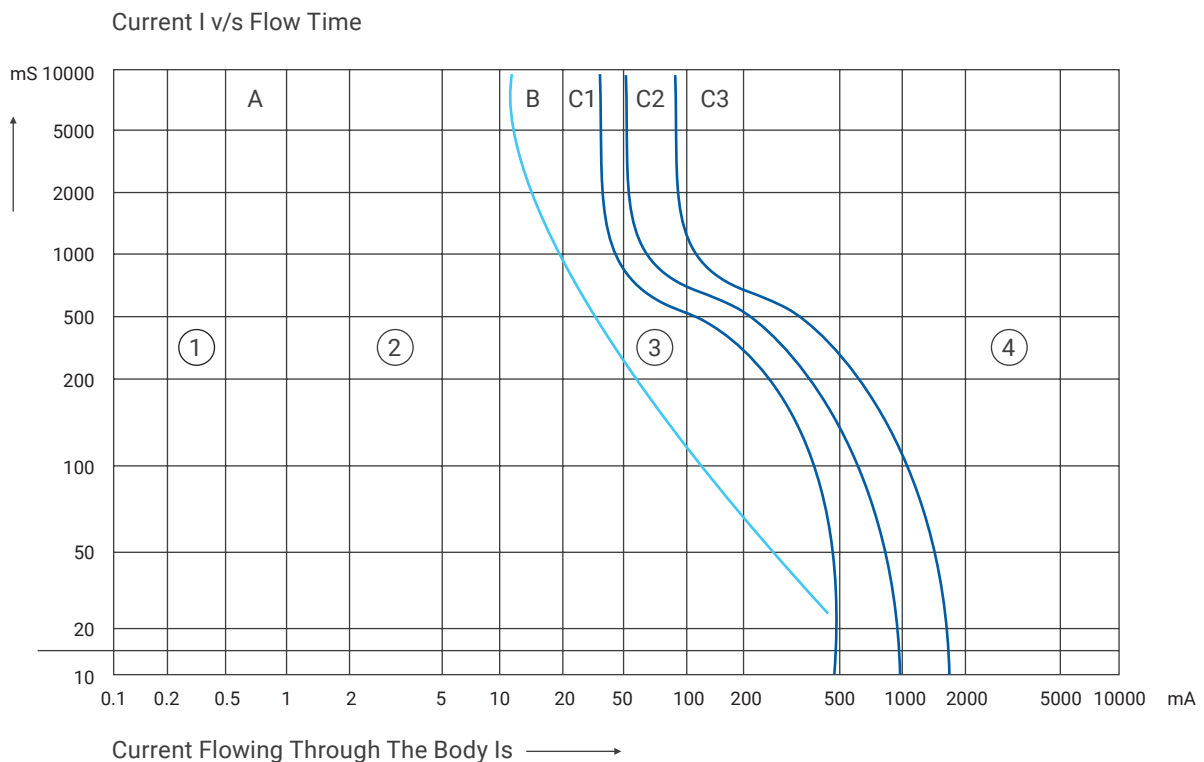

- ① Unperceived
- ② Perceived
- ③ Reversible effects : muscular contraction
- ④ Possible irreversible effects

C1= 5% risk C3>50% risk

Duration of current flow in the body as a function of current strength: In this graph, the effect of AC current (15 to 100 Hz) has been divide into four zones (as per IEC60479-1).

The gravity of an electric shock depends on the following factors:

- › Current value
- › Time it remains in the human body
- › Path it takes through the human body
- › Impedance of the human body
- › When a current in excess of 30 mA flows through part of the human body, the person is in danger if this current is not interrupted in a relatively short time.

Importance of RCCBs

The fault current overloads and short circuits can be detected by circuit breakers like MCBs, MCCBs, HRC Fuses, etc. But circuit breakers do not detect leakage currents which are dangerous for humans and livestock. If not detected, these leakages can lead to fire hazards. We need a solution that detects such leakage currents and disconnects the circuits from the power supply. Here comes the solution in the form of RCCBs (Residual Current Circuit Breakers) also known as ELCBs (Earth Leakage Circuit Breakers) which provides protection against direct and indirect contact of personnel or livestock and against fires.

Critical Current Thresholds

According to the medical study, effect of various current levels on human bodies is as shown below.

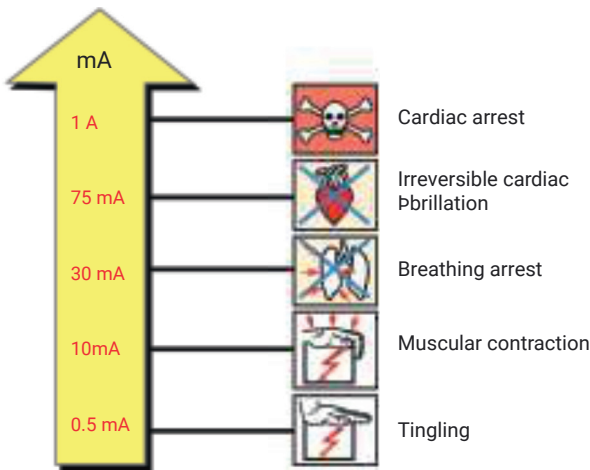

RCCBs operate by measuring the current balance between two conductors using a differential current transformer. This measures the difference between the current flowing out of the live conductor and that returning through the neutral conductor. If these do not sum to zero, there is a leakage of current to somewhere else (to earth/ground, or to another circuit), and the device will open its contacts.

RCCBs have different current sensitivities which can be used for various applications.

Sensitivities	Application
30mA	For protection against direct contacts
100mA	For protection against indirect contact (where generally leakage is high)
300mA	For protection against industrial installations, fire, etc.

To ensure safety, the RCCBs switches turn off the protected circuit immediately. If there is an insulation fault causing a short-circuit to an exposed part (frame etc.) of machinery and equipment (protection against indirect contact), the maximum permissible touch voltage U must occur at a residual current greater than or equal to the rated residual operating current I that triggers the In RCCBs. This condition is met by earthing the exposed part with a sufficiently low resistance to earth RE.

$$\text{Earth Resistance (RE)} < \frac{\text{Touch Voltage (U)}}{\text{Rated Residual Operating Current (I)}}$$

4.2 Working Principle of RCCBs

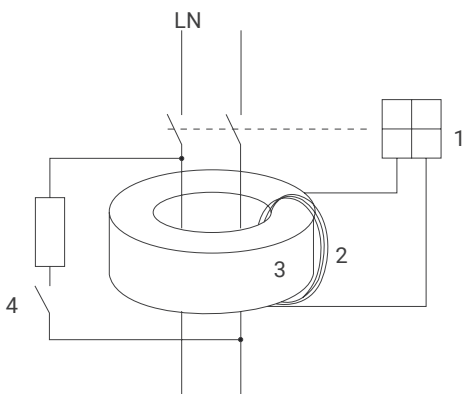

1. Electromagnet
2. Current transformer secondary winding
3. Transformer core
4. Test switch L live conductor N neutral conductor

4.3 Precaution for Installations

- › Wiring should be done as per the wiring diagram. by a trained and qualified electrician.
- › All wiring necessary for operation shall be passed through the RCCBs.
- › The neutral conductor must be insulated against earth to the same extent as the live conductors.
- › All equipment used must be properly earthed.
- › To ensure correct functioning, care must be taken that the neutral conductor on the load side of the RCCB must not be connected to earth, otherwise nuisance tripping may occur or tripping may be impaired.
- › Suitable device either MCBs or HRC fuses shall be used for short circuit and overload protection of the circuit under installation.

4.4 Fault finding when RCCB trips

Switch OFF all the switches/MCB connected in the circuit downstream the RCCB. Switch ON RCCB and switch ON the Switches one by one. You will find that during switching ON of a particular appliance/switch RCCB trips again and again which shows that this is the faulty circuit /appliance. Isolate the faulty circuit, rectify the fault and switch ON the RCCB.

Faults existing downstream of the RCD

- › **Indirect contact.** An RCD may be used to provide protection against electric shock due to indirect contact in an installation.
- › **Direct contact.** An RCD may be used to provide supplementary protection against direct contact.
- › **Incorrect application.** An RCD must be correctly selected and erected for the particular application. For example, protecting an entire installation using a single high sensitivity RCD can, in many cases, lead to unwanted tripping, particularly in industrial environments where inductive loads will cause greater transient overvoltages and where longer cable runs will result in larger values of capacitance to earth.
- › **No discrimination between series connected RCDs.** A fault downstream of two series-connected RCDs may result in operation of either device. A fault downstream of the second device will be 'seen' by both devices. Inconvenience may result if the upstream device operates. Discrimination, where required, must be ensured by means such as selecting a time delayed device for the upstream device.
- › **Loose connections.** A loose connection downstream of an RCD may cause it to operate due to transient voltages or capacitive effects. Every connection must be properly constructed of durable electrical continuity and adequate mechanical strength correctly selected enclosed and accessible, where required.
- › **Crossed neutral on split load distribution board or consumer unit.**

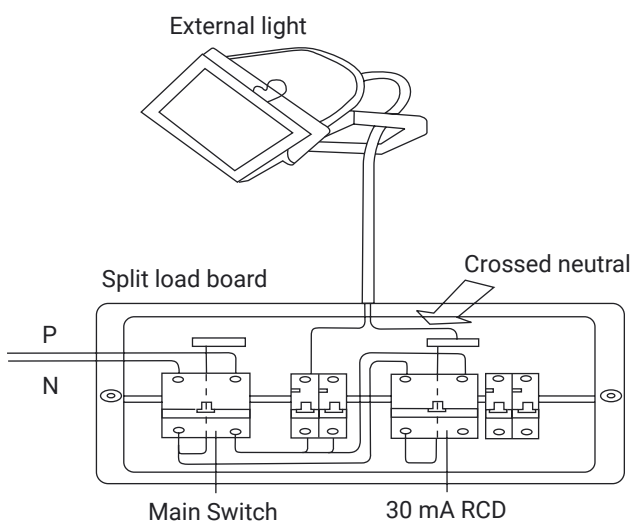

In the above diagram, the external lighting circuit has been incorrectly connected. The MCB supplying the circuit is connected to the non-RCD-protected side of the split load board but the neutral conductor for the circuit has been inadvertently connected downstream of the RCD. As soon as the outside light is energized, the RCD will see a large imbalance and will operate. The neutral must be taken from the same final circuit, never from another circuit, as has happened in this example. Circuits must be kept separate; in this example a 'borrowed neutral' situation exists presenting a potential shock risk for an electrician attempting to troubleshoot the problem.

- › **Neutral-to-Earth fault.** A neutral-to earth fault or inadvertent connection of neutral to earth downstream of an RCD will probably result in the device operating as part of the neutral current will flow in the circuit protective conductor resulting in the RCD seeing an imbalance (refer fig below). A neutral-to-earth fault can be caused by:
 - › A neutral conductor touching an earthed mounting box or earthed metal conduit
 - › Reversed neutral and earth connections at an accessory or item of current-using equipment
 - › Withdrawal of a fuse or switching off a circuit-breaker in a final circuit resulting in an RCD tripping as the neutral is normally not interrupted.
 - › Nails and picture hooks, screws and power drills: A floor board nail driven between the neutral and earth conductors creates a neutral to earth fault which is like to cause an upstream RCD to trip. The fault can be located by insulation testing. The damaged cable must be replaced and either relocated to avoid further damage or protected.
 - › Mineral insulated cables. Mineral insulated cables can absorb moisture if not correctly terminated resulting in reduced insulation which may cause an RCD to trip as a certain amount of outgoing phase current will return through the MI cable sheath causing the RCD to detect an imbalance. Insulation testing should identify the problem.
 - › Moisture ingress can cause reduced insulation resulting in RCD operation. Reduced insulation can result from wet plaster, condensation or water entry into accessories. Similarly, some appliances may exhibit reduced insulation causing RCD operation. Certain installed services, such as heating elements in cookers can have reduced insulation when cold; the insulation increasing when hot. The manufacturer's instructions should be consulted.
 - › Double-pole switching. Double pole switching within the fixed wiring is known to trip an RCD when switching off or on due to capacitive effects. Changing over from double pole to single pole switching can overcome the problem, where such replacement is permissible and safe.

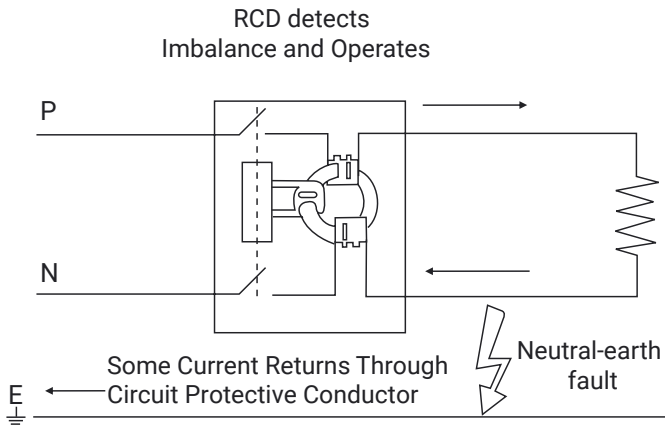

Faults Upstream of the RCD

A loose connection upstream of the RCD such as at the main switch or at the busbar connections can cause the device to operate.

Mains-borne disturbances such as spikes, voltage surges and dips, a lightning strike and the operation of distribution network switchgear and protective devices combined with capacitance to earth within the installation can cause unwanted RCD operation. A filter may be of assistance.

Site machinery or plant and installed services can cause mains borne interference. Motors such as lift motors, control gear for discharge lighting and transformer inrush currents can cause unwanted RCD operation. Although significant transients can arise within an installation they would normally only occur under fault conditions. They might, however, travel to other installations where they could cause unwanted tripping of a RCD.

Overhead lines: Unwanted tripping may occur more frequently in an installation supplied by overhead lines compared to one supplied by an underground concentric cable. An underground concentric cable is, by its very nature, a good attenuator of transient overvoltages. Spurious tripping may be avoided by installing a filter upstream of the RCD at the origin of the installation.

4.5 RCCBs : Domestic Installation

RCCBs can be installed mainly in two ways:

- › Whole house protection: In this type of protection the RCCBs serve as the main switch. This type of protection is very popular but has a major disadvantage that all the circuits are disconnected in the event of a fault.
- › Selective protection: This type of protection can be divided into two types.
 - » Split busbar consumer unit: In this case all circuits are fed through an overall isolator and selected circuits additionally through RCCBs. The examples of selected circuits are socket outlets, garage circuits, etc. So this reduces the inconvenience in the event of a fault.
 - » Per Phase Isolation (PPI): A RCCB is used as sub-incomer for each individual phase. In case of a fault, only faulty phase will be disconnected and remaining phases will not be affected.

RCCB should be protected against overload and short-circuit by using backup MCB or Fuse as per table below:

RCCB Rating (A)	Lauritz Knudsen MCB (A)	gG Lauritz Knudsen Fuse (A)
25	25	25
40	40	40
63	63	63
100	100	100

Add an Appeal to your Wall with our Range of Distribution Boards



Outside, it's a work of art. The aesthetic line of the Lauritz Knudsen-Electrical & Automation: Distribution Boards, gives your home a touch of subtle elegance. It is a style statement!

Inside, it's state-of-the-art. Lauritz Knudsen- Electrical & Automation Distribution Boards are designed for total safety. They are easy to install, operate and maintain. What's more, this range ensures that there's atleast one DB for your application.

Contact your nearest authorised Lauritz Knudsen- Electrical & Automation stockist today.

Switchgear Training Centres



Pune

Lauritz Knudsen Electrical & Automation
Switchgear Training Centre
T-156 / 157, MIDC,
Bhosari, Pune - 411 026
Tel: 020-2712 0037 / 2712 0653
E-mail: STC-PUNE@LK-EA.com



Lucknow

Lauritz Knudsen Electrical & Automation
Switchgear Training Centre
C-6 & 7, UPSIDC,
P. O. Sarojininagar,
Lucknow - 226 008
Tel: 97944 54455
E-mail: STC-LUCKNOW@LK-EA.com



Delhi

Lauritz Knudsen Electrical & Automation
Switchgear Training Centre
A-25, Imperia Complex, First Floor
Mohan Cooperative Industrial Estate
Near Sarita Vihar / Mohan Estate Metro Station
Main Mathura Road, New Delhi - 110044
Tel: 9899020306 / 9720186726 / 9560845094
E-mail: STC-DELHI@LK-EA.com



Kolkata

Lauritz Knudsen Electrical & Automation
Switchgear Training Centre,
2nd Floor, Block BN3, Sector V,
Salt Lake City,
Kolkata - 700091, West Bengal
Tel: 7738717893 / 7797795567
E-mail: STC-KOLKATA@LK-EA.com



Vadodara

Lauritz Knudsen Electrical & Automation
Switchgear Training Centre
Behind L&T Knowledge City,
Near Village Ankhol,
Vadodara - 390019
Tel: 0265 6147805 / 6147808
E-mail: STC-VADODARA@LK-EA.com



Coonor

Lauritz Knudsen Electrical & Automation
Switchgear Training Centre
Ooty-Coonor Main Road
Yellanahalli P.O.,
The Nilgiris - 643 243
Tel: 0423 251 7107
E-mail: STC-COONOOR@LK-EA.com

Customer Interaction Center (CIC)
Phone no: 022 6932 7800
Web: www.LK-EA.com | e-mail: CIC@LK-EA.com



Electrical Standard Products (ESP) Offices

HEAD OFFICE

Lauritz Knudsen Electrical & Automation, A/600, Shil-Mahape Road, TTC Industrial Area, MIDC Thane, Navi Mumbai, 400 710, Maharashtra.

Tel: 022-6722 6300 | Fax: 022-6705 1112 | e-mail: CIC@LK-EA.com

BRANCH OFFICES

Lauritz Knudsen Electrical & Automation
C-201, The First Commercial Complex,
B/S Keshavbaug Party Plot, Vastrapur,
Ahmedabad - 380 015
Phone No: 022-6932 7800
e-mail: CIC@LK-EA.com

Lauritz Knudsen Electrical & Automation
Shri Daneshwari, 1st Floor,
Plot No. 17, 2nd Cross, Near Old Income
Tax Office Road, Vidyanagar,
Hubballi - 580 021
Phone No: 022-6932 7800
e-mail: CIC@LK-EA.com

Lauritz Knudsen Electrical & Automation
No.10, Fortuna Towers, 2nd Floor,
Rana Pratap Marg, Near NBRI,
Lucknow - 226 001
Phone No: 022-6932 7800
e-mail: CIC@LK-EA.com

Lauritz Knudsen Electrical & Automation
A06/A07, Second Floor,
Grand Chandra Complex, Frazer Road
Patna - 800 001
Phone No: 022-6932 7800
e-mail: CIC@LK-EA.com

Lauritz Knudsen Electrical & Automation
Wework Central, #36 Infantry Road,
Bengaluru - 560 001
Phone No: 022-6932 7800
e-mail: CIC@LK-EA.com

Lauritz Knudsen Electrical & Automation
AWFIS Space Solutions, Prestige Phoenix,
4th floor, 1405, Umanagar, Begumpet,
Hyderabad - 500 016
Phone No: 022-6932 7800
e-mail: CIC@LK-EA.com

Lauritz Knudsen Electrical & Automation
El Dorado Building, 3rd Floor, 6,
Venkatraman Street, Chinna Chokkikulam,
Madurai - 625 002
Phone No: 022-6932 7800
e-mail: CIC@LK-EA.com

Lauritz Knudsen Electrical & Automation
UrbanWrk, 5th Floor, Sai Radhe,
Raja Bahadur Mill Road, Behind Hotel
Grand Sheraton, Sangamwadi
Pune - 411 001
Phone No: 022-6932 7800
e-mail: CIC@LK-EA.com

Lauritz Knudsen Electrical & Automation
Workloop Unit-612, 6th Floor,
Esplanade One, Rasulgarh,
Bhubaneswar, Odisha-751010
Phone No: 022 6932 7800
e-mail: CIC@LK-EA.com

Lauritz Knudsen Electrical & Automation
Workie, 214 - 2nd Floor,
Apollo Premier, PU-4,
Scheme No. 54, Vijay Nagar Square,
Indore - 452 010
Phone No: 022-6932 7800
e-mail: CIC@LK-EA.com

Lauritz Knudsen Electrical & Automation
Bestech Business Park,
Tower - A, 2nd floor, Sector - 66
Mohali - 160059
Phone No: 022-6932 7800
e-mail: CIC@LK-EA.com

Lauritz Knudsen Electrical & Automation
Office No. 211 & 212, Pithalia Plaza,
KK Road, Near Fafadih Chowk,
Raipur - 492 001
Phone No: 022-6932 7800
e-mail: CIC@LK-EA.com

Lauritz Knudsen Electrical & Automation,
The Executive Centre
Level 8, Olympia Teknos Park
28, SIDCO Industrial Estate, Guindy,
Chennai - 600 032, Tamil Nadu,
Phone No: 022-6932 7800
e-mail: CIC@LK-EA.com

Lauritz Knudsen Electrical & Automation
Office No. 430, 4th Floor,
Jaipur Electronic Market, Riddhi Siddhi,
Gopalpura Bypass,
Jaipur - 302 018
Phone No: 022-6932 7800
e-mail: CIC@LK-EA.com

Lauritz Knudsen Electrical & Automation
TC II, Tower B, PRIMA BAY Gate No. 5,
Saki Vihar Road Powai,
Mumbai - 400 072
Phone No: 022-6932 7800
e-mail: CIC@LK-EA.com

Lauritz Knudsen Electrical & Automation,
DevX 4th Floor, A Wing, Om 9 Square,
150 Ft Ring Road, Near Nana Mava Circle,
Opp Silver Heights,
Rajkot - 360 001
Phone No: 022-6932 7800
e-mail: CIC@LK-EA.com

Lauritz Knudsen Electrical & Automation
Playworkz Coworking Space
43 & 44, 3rd Cross,
Bharathy Colony, Peelamedu,
Coimbatore - 641 004
Phone No: 022-6932 7800
e-mail: CIC@LK-EA.com

Lauritz Knudsen Electrical & Automation
GDR Siddha, Ground Floor, N Road
Bistupur, Opposite St. Mary's Church,
Jamshedpur - 831 001
Phone No: 022-6932 7800
e-mail: CIC@LK-EA.com

Lauritz Knudsen Electrical & Automation
Unnati Building, 2nd Floor,
Automation Campus, A-600, TTC Industrial
Area Shil-Mahape Road, Mahape,
Navi Mumbai - 400 710
Phone No: 022-6932 7800
e-mail: CIC@LK-EA.com

Lauritz Knudsen Electrical & Automation
10th Floor, Titaanium Business,
Bhimrad Road, Althan
Surat - 395 017
Phone No: 022-6932 7800
e-mail: CIC@LK-EA.com

Lauritz Knudsen Electrical & Automation
3rd Floor, 1&2 Vijay Park,
Main Chakrata Road, Opp. Anandam,
Near Ballapur chowk,
Dehradun - 248 001
Phone No: 022-6932 7800
e-mail: CIC@LK-EA.com

Lauritz Knudsen Electrical & Automation
Business Communication Centre
2nd Floor, Chiramel Chambers,
Kurisupally Road, Ravipuram,
Kochi - 682 015
Phone No: 022-6932 7800
e-mail: CIC@LK-EA.com

Lauritz Knudsen Electrical & Automation
M1 & M2, Mezzanine Floor,
Himalaya Excellency,
Plot No. C-47, Pratap Nagar Square,
Nagpur - 440 022
Phone No: 022-6932 7800
e-mail: CIC@LK-EA.com

Lauritz Knudsen Electrical & Automation
11th Floor, Block-D, Notus IT Park,
Sarabhai Campus, Bhailal Amin Marg,
Vadodara - 390 023
Phone No: 022-6932 7800
e-mail: CIC@LK-EA.com

Lauritz Knudsen Electrical & Automation
Ground Floor, B-27,
Biplab Rashbihari Sarani,
Sector 2A, Bidhan Nagar,
Durgapur - 713 212
Phone No: 022-6932 7800
e-mail: CIC@LK-EA.com

Lauritz & Knudsen Electrical & Automation,
207, 2nd floor, Revolution Complex,
Station Road, E Ward,
Next to Pedestrian Bridge,
Kolhapur - 416 001
Phone No: 022-6932 7800
e-mail: CIC@LK-EA.com

Lauritz Knudsen Electrical & Automation,
3rd floor, Uttam Tower by Viraj Estate,
Sharanpur Road,
Nasik - 422 002
Phone No: 022-6932 7800
e-mail: CIC@LK-EA.com

Lauritz Knudsen Electrical & Automation
Naga Chambers, 3rd Floor, D/No. 12-1-16,
Plot No. 49, Survey No. 1051, Waltair Main Road,
Visakhapatnam - 530 002
Phone No: 022-6932 7800
e-mail: CIC@LK-EA.com

Lauritz Knudsen Electrical & Automation
6th Floor, Exotica Greens, A Block, 191,
R G Baruah Road, Guwahati Central,
Guwahati - 781 005
Phone No: 022-6932 7800
e-mail: CIC@LK-EA.com

Lauritz Knudsen Electrical & Automation
2nd Floor, BN3, Salt Lake, Sector-V,
Kolkata - 700 091
Phone No: 022-6932 7800
e-mail: CIC@LK-EA.com

Lauritz Knudsen Electrical & Automation
A-25, 1st Floor, Imperia Complex,
Mohan Corporate Industrial Estate,
Near Sarita Vihar Metro Station,
Mathura Road,
New Delhi - 110 044
Phone no: 022-6932 7800
e-mail: CIC@LK-EA.com

Product improvement is a continuous process. For the latest information and special application, please contact any of our offices listed here. Product photographs shown for representative purpose only.



Lauritz Knudsen Electrical & Automation, Electrical Standard Product

A/600, Shil-Mahape Road, TTC Industrial Area, MIDC Thane, Navi Mumbai, 400 710, Maharashtra, Phone No: 022-6722 6300 | Web: www.LK-EA.com

Customer Interaction Center (CIC)

Phone no: 022-6932 7800

Web: www.LK-EA.com | e-mail: CIC@LK-EA.com